

Index

Chapter 1. Introduction

Key Features	...	2
Package List	...	2
Product View	...	3
Indicators	...	4
System Requirement	...	4

Chapter 2. Setup Guide

Software Installation	...	5
Initial Configuration	...	5
Hardware Installation	...	7
Browsing Video & Audio	...	7

Chapter 3. Control & Configure IP Camera

Camera Control	...	8
Splits	...	10
Operation Mode	...	10
Right Click Control	...	11
View Log	...	13
Add a camera window	...	14
Configuration	...	15

Chapter 1. Introduction

Thank you very much for purchasing our products. Please follow instructions and start to experience IP camera technologies wirelessly brought you by advanced Technologies.

Key Features

- Up to 30 frames per second at 640x480 resolution
- IEEE 802.11b wireless interface
- Motion detection
- GPIO: external sensor/alarm connect
- Built-in microphone
- View with Internet browsers

Package List

Please check if you have everything on following list in your package and make sure they are not damaged.

- IP camera
- 5V 2A AC/DC adaptor
- Crossover network cable
- Software CD (IP Edit & User manual)
- Camera brackets

Product View

Front view picture



Rear view picture



Indicators

LED	Light Color	Description
Power	Green	IP camera is powered on
	Dark	IP camera is powered off
Link	Green (Blinking)	LAN connecting
	Dark	LAN disconnected
Wireless	Green (Blinking)	WLAN connecting
	Dark	WLAN disconnected

System Requirement

Wireless Access Point (802.11b compatible): to use wireless interface of IP camera, a wireless access point must have pre-installed.

All computers running following platform and following browser installed can be used to view IP camera.

-Platform: Microsoft Windows 98, Windows Me, Windows NT 4.0, Windows 2000, Windows XP, Linux, Mac compatible.

-Browser: Microsoft Internet Explorer 5.x, 6.x & later version and Netscape Navigator 5.x and later version.

Chapter 2. Setup Guide

Software Installation

1. Insert installation CD, click 'Install configuration software' on your computer.
2. Follow instructions guided by installation wizard, finish the installation.

Initial Configuration

1. Connect IP camera and your computer with the crossover network cable in the package.
2. Load 'IP Editor' program.

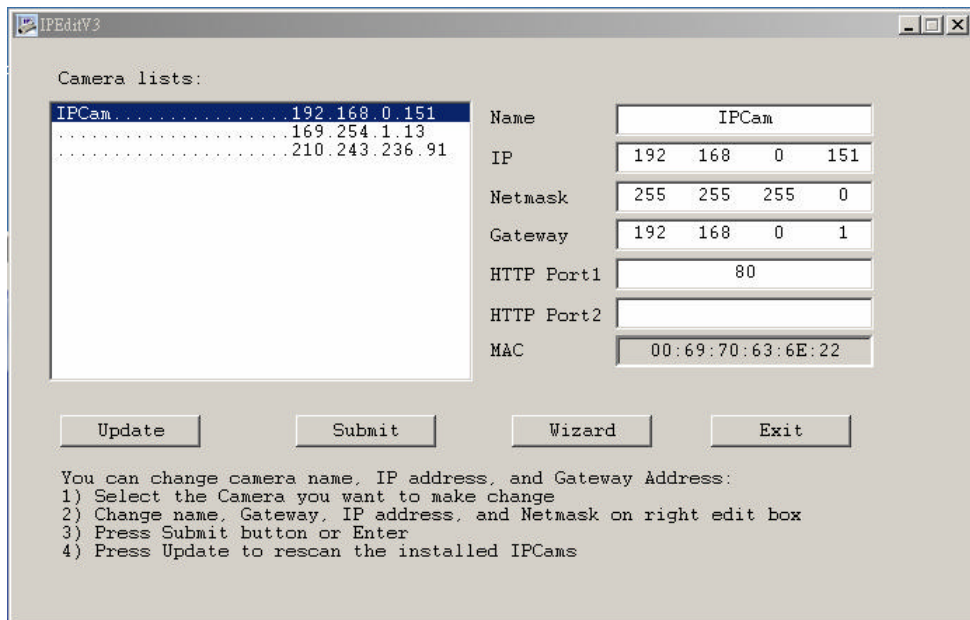

IP Editor™

3. The program will search all your IP cameras in this network automatically.

4. Click on the camera to start configuration.
5. Basic Configuration: If you are going to set a static IP to this IP camera, you can just add your IP information in the forms on right of the panel.

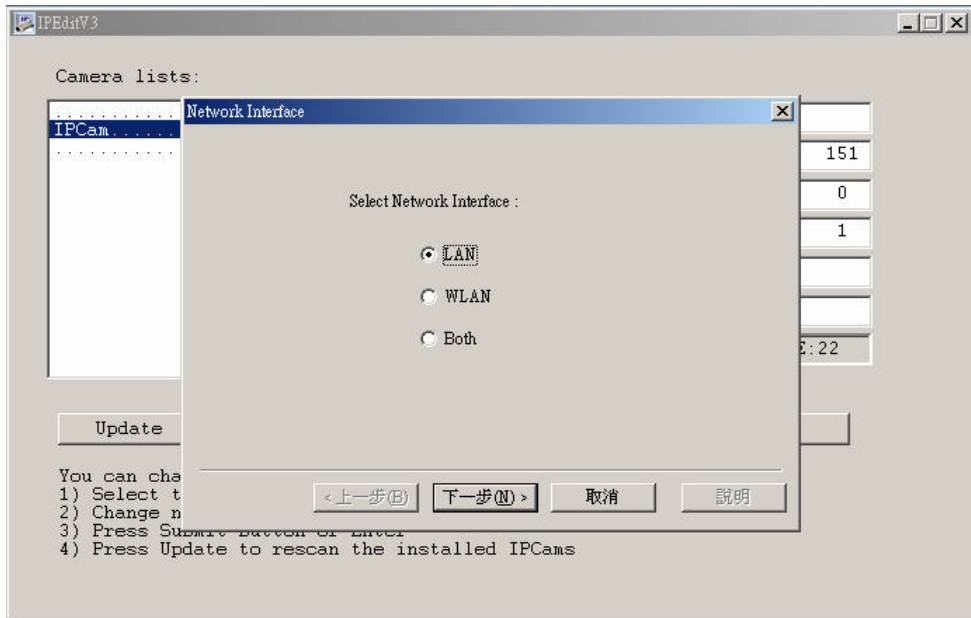

Configuration Wizard window

6. Configuration Wizard: If you want to configure your IP camera step by step, you can select the camera and click 'Wizard' to start; you can configure all settings through configuration wizard.
7. ***If you choose to get IP from DHCP, DHCP of AP or PPPoE, you will need to configure mail server and mail account information so that IP Cam will send it's latest IP address to your email.***

Hardware Installation

1. Fix your IP camera with the camera bracket.
2. Connect IP camera and power plug with AC/DC adaptor.
3. Connect IP camera and switch/hub with network cable if you don't want to use wireless interface.
4. Check LED indicators; make sure that power LED is on, LAN or WLAN LED indicator is blinking.

Browsing Video & Audio

ActiveX setting on your Internet Explorer: you must enable ActiveX function before browsing an IP Camera.

Load your Internet Explorer, select **<(I) tools >** on function list, than enter 'internet setting'. Select option 'security', and choose **(C) customize** on 'internet' region; select **start** on every Active X control related items.

Finding your IP camera on the network

1. Load IP Editor program on a local computer, it will scan all IP camera in local network.
2. Double click on the camera name (default name: IP Cam), it will initial your browser and go to home page of this IP camera.
3. Click on the enter sign and you will be redirect to camera control page.

Chapter 3. Control & Configure IP Camera

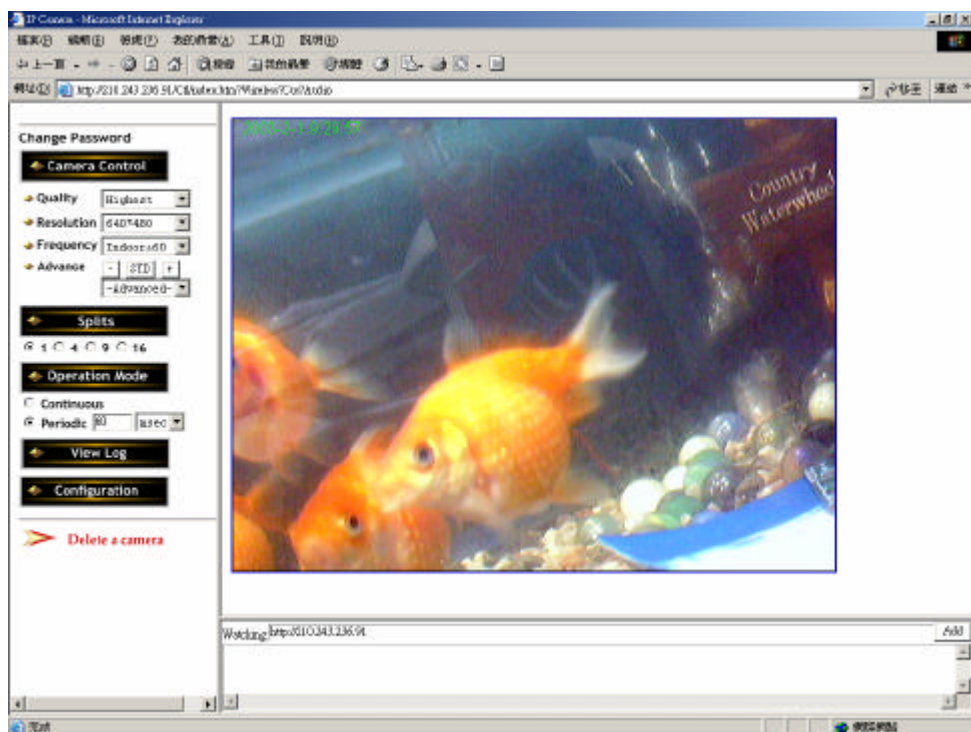

User Interface

Camera Control



Camera control panel on the left page

Resolution: the resolution that you want IP camera to serve you. The larger the resolution value is, the more bandwidth it will take when sending video. 5 levels of resolutions are available in IP camera (640x480, 320x240, 160x120, 352x248, 176x144).

Frequency: to filter the video aberration caused by different frequency of fluorescent lamp (usually depends on power system of the country), you can select the frequency that your lightening is. Default setting is 'out door'.

Advanced: video parameters setting, you can adjust 3 video parameters (Saturation, Hue, Sharpness) by clicking (+) increase and (-) decrease; click [STD] to back to default.

Splits



1 4 9 16

This function enables you to watch video by contiguous separated images. 4 splits modes are available (1, 4, 9 and 16). This function is usually used in periodic mode such as internet connecting, you can watch both currently and previously pictures.

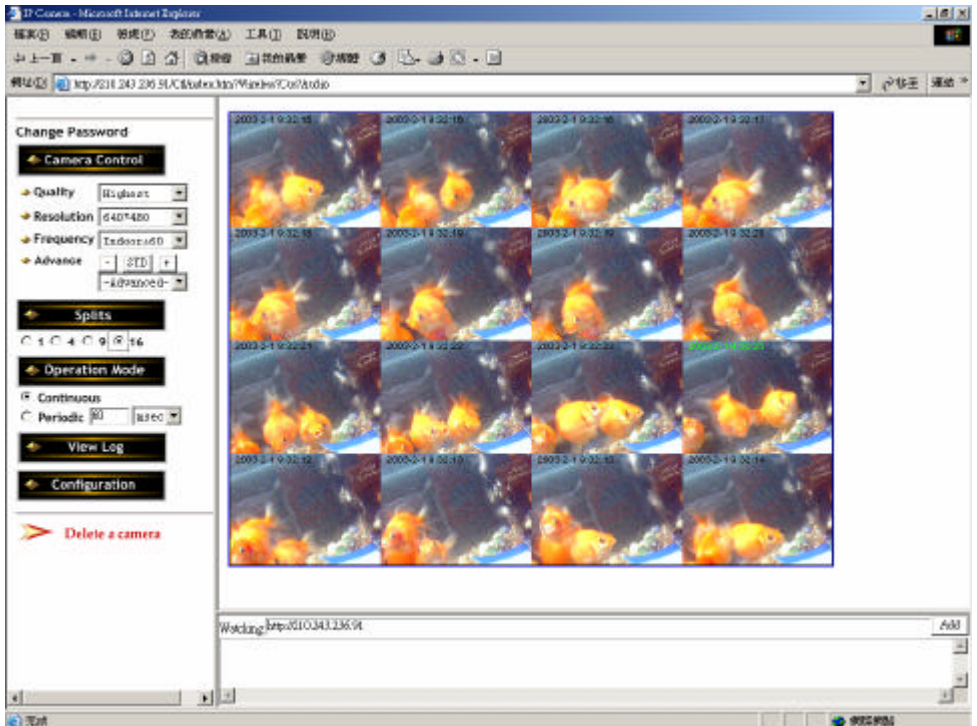

Splits Screen of IP camera: (16, 4x4)

Operation Mode

◀ Operation Mode

Continuous

Periodic

Here you can choose what kind of operation mode you prefer your IP cam to serve you.

Continuous (default) usually used when you have no network bandwidth issue (ex. Intranet). **Periodic** is used when network bandwidth is limited such as Internet connecting or for multiple users link con-currently. In **Periodic** mode, you will need to set interval time between pictures.

Right Click Control On Camera Window

Right click on camera window, user can do following control:

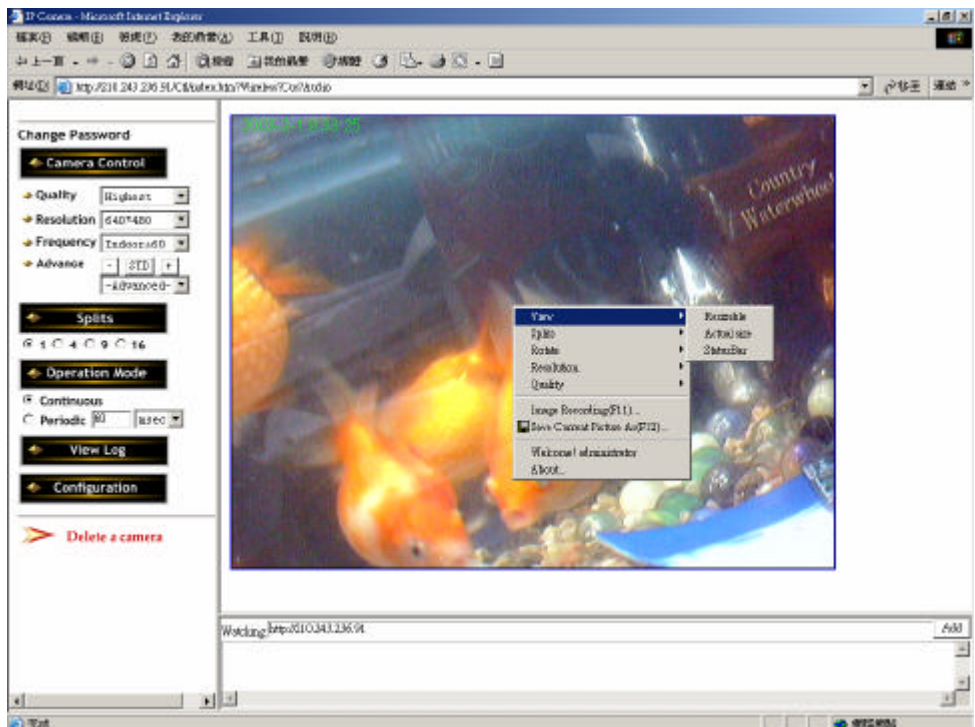

Right click on the camera window, a function list will appear.

View

Resizable: User can resize the camera window by dragging the window border.

Actual Size: Fix the window size to actual resolution.

Status Bar: To show IP camera status in the bottom of the camera window.

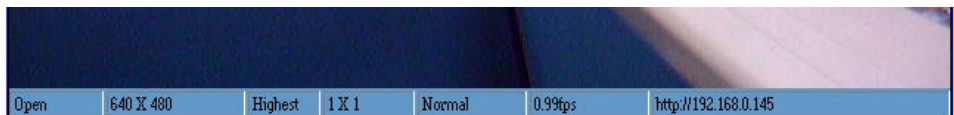

Splits

This function enables you to watch video by contiguous separated images. 4 splits modes are available (1, 4, 9 and 16).

Rotate

User can reverse image when camera is put up side down or when they have some specific purpose to rotate/flip image.

Resolution: the resolution that you want IP camera to serve you. The larger the resolution value is, the more bandwidth it will take when sending video. 5 levels of resolutions are available in IP camera (640x480, 320x240, 160x120, 352x248, 176x144).

Quality: the video quality that you want the IP camera to serve you. The better quality you select, the more bandwidth it will take when sending video. 5 video quality levels are available in IP camera (low<high<medium<clarity<motion).

Image Recording:

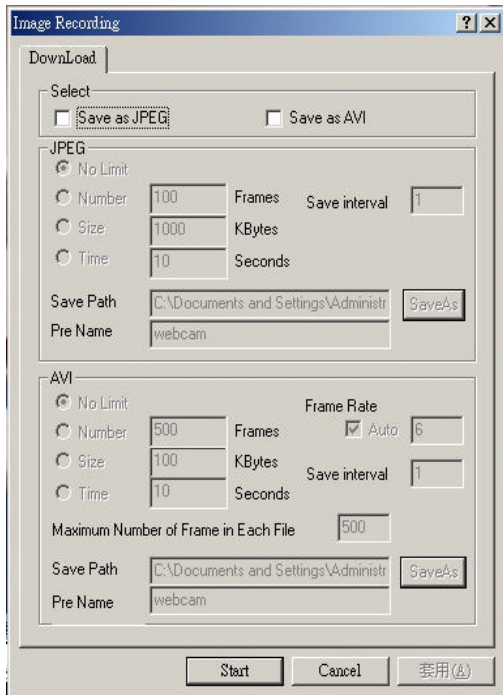

User can preset the format they prefer to record their video files (***continuous pictures or AVI video files***) and the path they prefer to save image or video files. User can either limit file size, number of frames, recording times for storage consideration or set it to No Limit. Pre name means characters that before auto generate file names; it is for user to manage their image/video files more easily. After above setting is done, user can click **<Start>** to start

recording or use hot key **[F11]** to start.

Save Current Image: User can save current picture to your computer by this function or press hot key **[F12]** do the same job, too.

Add an IP Camera Window

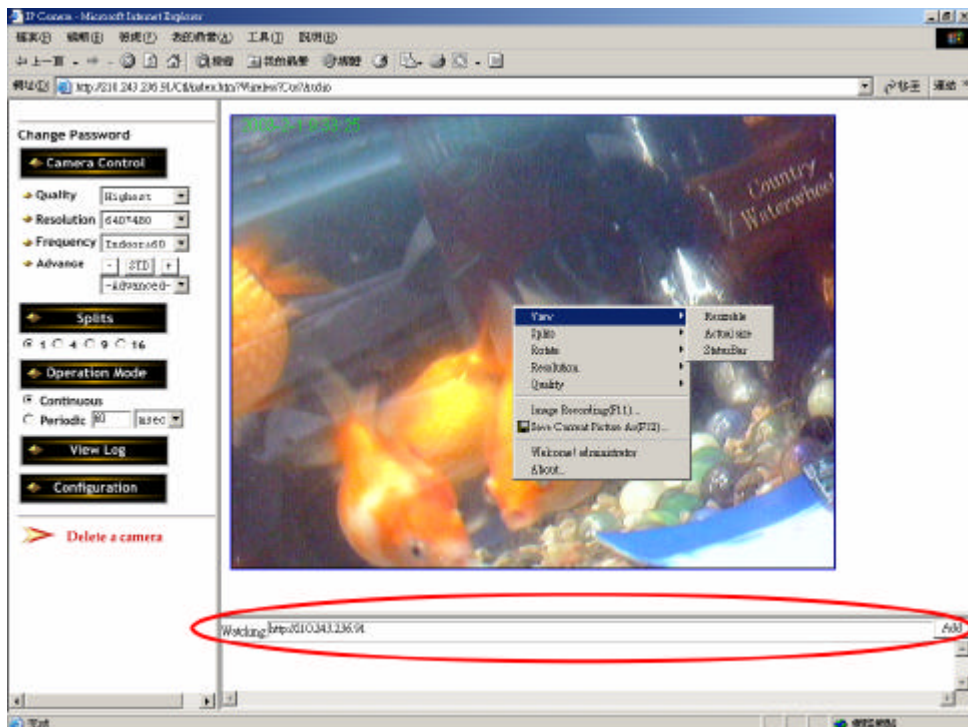

Fill IP of another IP cam and click 'Add'

If you have multiple IP camera, you can add camera windows in the same page. Just fill in the IP address of the IP camera on the address table and click <Add> or press [enter], a new camera window will be added to the page above. Up to 9 camera windows are supported to be view at the same time in a page.



Delete a camera

If you have multiple camera windows on your page and you want delete one of them, just select the window (by clicking on it; blue border will appear when a window is selected) and click on '*Delete a camera*' on the left page.

View Log



The screenshot shows a web browser window displaying the 'IP Camera Logs' page. The left sidebar contains navigation buttons: 'Change Password', 'Camera Control', 'Splits', 'Operation Mode', 'Camera Window', and 'Configuration'. The 'Delete a camera' button is highlighted in red. The main content area shows a table of logs with the following data:

Msg Info	Appended Info	Operator IP	Operator MAC	Time
System Boot				6/25/2004 12:36
New client		210.343.236.89	00:10:2B:00:BD:E5	6/25/2004 12:36
New client		127.0.0.1		6/25/2004 12:34
New client		210.343.236.90	00:05:5D:01:8C:0F	6/25/2004 12:44
Change resolution 0		210.343.236.90	00:05:5D:01:8C:0F	6/25/2004 12:44
Change resolution 3		210.343.236.90	00:05:5D:01:8C:0F	6/25/2004 12:45
New client		211.167.236.86		6/25/2004 12:47
Change resolution 0		210.343.236.90	00:05:5D:01:8C:0F	6/25/2004 12:41
Change resolution 3		210.343.236.90	00:05:5D:01:8C:0F	6/25/2004 12:54
Change resolution 0		210.343.236.90	00:05:5D:01:8C:0F	6/25/2004 12:54
Change quality 3		210.343.236.89	00:10:2B:00:BD:E5	6/25/2004 13:23
Change resolution 5		210.343.236.89	00:10:2B:00:BD:E5	6/25/2004 13:23
Change resolution 2		210.343.236.89	00:10:2B:00:BD:E5	6/25/2004 13:23
Change resolution 3		210.343.236.89	00:10:2B:00:BD:E5	6/25/2004 13:25

Log page

This function allows camera administrators to trace client IP, configuration that is set, system information.. etc.

Configuration



Main Info	Appended Info	Operator IP	Operator MAC	Time
System Boot				6/25/2004 12:6
New client		210.243.236.89	00:10:2B:00:BD:E5	6/25/2004 12:36
New client		137.50.1		6/25/2004 12:34
New client		210.243.236.90	00:05:5D:E1:8C:0F	6/25/2004 12:44
Change resolution	0	210.243.236.90	00:05:5D:E1:8C:0F	6/25/2004 12:44
Change resolution	3	210.243.236.90	00:05:5D:E1:8C:0F	6/25/2004 12:45
New client		211.167.226.86		6/25/2004 12:47
Change resolution	0	210.243.236.90	00:05:5D:E1:8C:0F	6/25/2004 12:48
Change resolution	3	210.243.236.90	00:05:5D:E1:8C:0F	6/25/2004 12:54
Change resolution	0	210.243.236.90	00:05:5D:E1:8C:0F	6/25/2004 12:54
Change quality	3	210.243.236.89	00:10:2B:00:BD:E5	6/25/2004 13:23
Change resolution	3	210.243.236.89	00:10:2B:00:BD:E5	6/25/2004 13:23
Change resolution	2	210.243.236.89	00:10:2B:00:BD:E5	6/25/2004 13:23
Change resolution	3	210.243.236.89	00:10:2B:00:BD:E5	6/25/2004 13:25

Configuration (System)

System

This page user can configure basic information for this IP camera, such as camera name, camera time, and TCP port you prefer to use for web server of IP camera.

Camera Name: You can fill in the camera name you prefer to use such as 'living room' and click <change>, so when you view with browser, camera name will be showed on the image. Camera name will be showed when

you scanning IP camera by IP Editor program, too.

Time Change: There are 3 ways you can change camera time, you can either sync time with a time (NPT) server or sync with a PC you are using to browse IP camera; or user can change the time by manually input.

HTTP ports: User can set up to 2 TCP ports for web servers of IP camera. Default port number is 80 (standard web server port). No 2nd port is preset. If you are not using port 80, you will need to follow a port number after the IP address when viewing your IP camera. Ex.: If your IP address is 192.168.0.100 and you set port 88 for the web server you will need to type: <http://192.168.0.100:88/> to view your IP camera.

**If you want to restore factory default configuration, click 'restore factory default configuration' in bottom of this page.*

**To Reboot this IP camera, you can click 'Reboot IP Cam' in the bottom of this page.*

Warning *Do not use 'firmware upgrade' function unless you have new firmware provide by our company. Upgrade manual will provide with new firmware.*

User

For security purpose, IP camera provides authorization mechanism. Check **Yes** to enable this function.

2 level user privileges are defined in IP camera. A default user who is highest privileged - 'admin' is defined; default password for administrator

is 'admin'. User who owns this account can do every setting or system configuration to this IP camera; when other users can only do little change when viewing with browser.

Motion Detect

IP camera provides Motion Detect function. There are 3 levels of sensitivities (High, Medium and Low). If you would like to use this function, check **Enable** and select the sensitivity you prefer. Then you will need to select the way to react with motion event. Here IP camera provides send event pictures to either Email account or FTP server preset. It is not recommended to check both at the same time. It will decrease performance enormously.

** Motion Detect caused heavy loading of IP camera Series performance may be impacted when this function is enabled.*

Network

In this page user can configure both LAN and WLAN interfaces. If you are using PPPoE (xDSL), put in your connection information here (username & password); If you have done in IP Editor program, then you don't need to fill it again. **DHCP mail** is a function that once IP camera gets an IP from DHCP server, it will send this IP information to the email preset in the following forms.

To send the IP when DHCP or PPPoE get one, please fill in a mail account information including SMTP server, username/password, we recommend user to use the account and SMTP server provide by your ISP.

Then, please fill sender and receiver email and also the mail subject you want to use.

Wireless Interface

To use wireless interface of IP camera, user might need to configure this page to connect with wireless network.

Network Name (ESS ID): Fill in your wireless network name. It is configured in your wireless access point.

Channel: If you need specific channel to connect with your wireless network device, you can set up here. **By default, it is always auto detected.**

Operation Mode: If you are using a wireless access point (AP) to connect IP camera please select **Infrastructure Mode**. If you are using peer-to-peer connection (computer direct to IP camera), please select **Ad-Hoc Mode**.

WEP Settings: For wireless security reason, most wireless access points have encryption function called **WEP**. If your wireless AP has been enabled WEP function, you will need to set up WEP on IP camera to connect with your AP. Check **Disable** if you are not using WEP on your AP. If you do, check the kind of encryption method you're using and fill in the code. Click **<Set>** to save setting.

Audio

IP camera supports sound effect through browser, audio configure page allows user to enable/disable this function. Users can also choose what kind of video format they prefer to use. PCM (64 bit) performs better quality but takes more Bandwidth than ADPCM (32 bit) at the same time.

User can decide to enable audio or not or which sound format to use according to network bandwidth.

DDNS

DDNS allow PPPoE dynamic IP users to access their IP camera by single domain name. IP camera supports DDNS which meets standard of Dynamic Network Services, Inc.. User can go to www.Dyndns.org to register your own domain name and get a username/password. Fill in your username/password and domain name information on DDNS setting page. Once PPPoE dialed, IP camera will update it's IP to DDNS automatically. So users can access IP camera always by a domain name.



DynDNS.org home page

Access List

This function allows user to define specific IP addresses that they want to allow or disallow accessing IP camera. You can define only reject or only accept IP addresses here and enable/disable this function.

Check **Enable** to apply this function in **IP Management**; **Disable** if you do not need this function at this time.

Mode: When you enable IP function, you can choose **Reject** (Accept all except those on reject list) or **Accept** (Reject except on accept list) rule.

Add/Delete an IP address

Put in an IP address and select weather you want to accept or reject this address.

GPIO

This function allows user to define external digital input/output device.

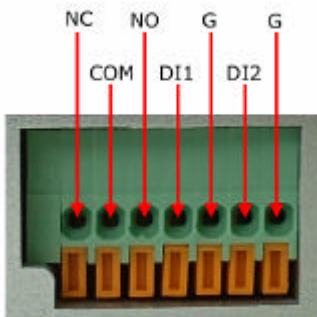

GPIO Interface diagram

Digital Input

Before you connect your external device (sensor or input device) to IP camera, please make sure what operation type is it first. If it is a 'normal closed' device, please check **Normal Closed**; in contrast, if it is a 'normal opened' one, then please check **Normal Opened**.

After setting up Digital input, there are 3 options you can choose the way to react when DI triggered (either send pictures to Email or FTP preset or trigger DO).

Digital Output

Before you connect your external device (such as alarm or other output device) to IP camera, please make sure what operation type is it first. If it is a 'normal closed' device, please check **Signal 1 (ON->OFF)**; in contrast, if it is a 'normal opened' one, then please check **Signal 2 (OFF->ON)**.

User can also turn on or off external output device manually on this page by checking **ON / OFF (Manually)**

LED Control

Here you can control IR LED (for night vision). Check **Enable** to start this function. You can either select **automatically** so that the LED on IP camera will turn on or turn off by itself whenever it's getting too dark or lightening is enough. You can also manually turn it on/off on webpage.